

D2RB 差動コネクタ、基板用 100Ω スナップ ロック Differential Connectors for PC Board, Snap Lock

Actual Size
実物大

Small Connector with 100Ω matched impedance differential pair.
The differential pair reduces any noise occurred by interference or crosstalk.

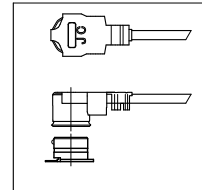

Insulation resistance		400MΩ min at DC 100V
Voltage rating		AC 50Vrms max at sea level
Dielectric withstanding voltage		AC 50Vrms at sea level
Temperature range		-40°C~+105°C
Contact durability		less than 25mΩ after 50 matings
Major Material	Shell	Brass
	Insulator	High temperature plastics, low electric permittivity. Black
	Center Contact	Beryllium copper Gold plating over Ni plating

Specifications subject to change without notice.

リセプタクル Receptacle D2BF-R-VT-SMT

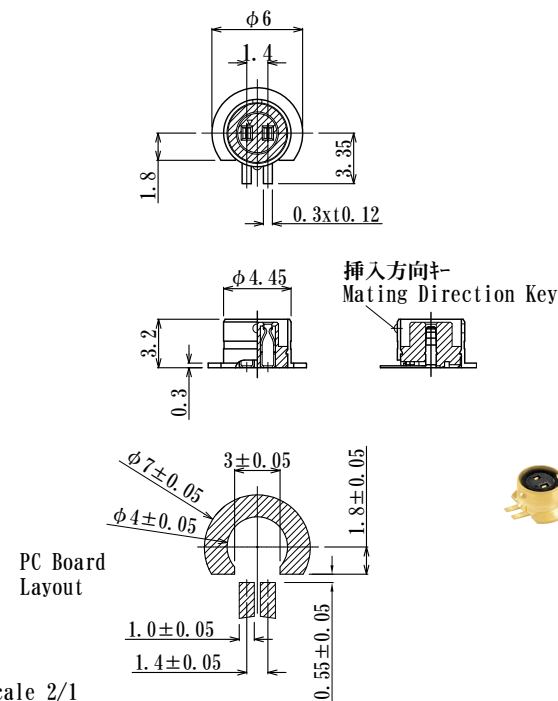

プラグ Plug D2BF-P-RA-CBL

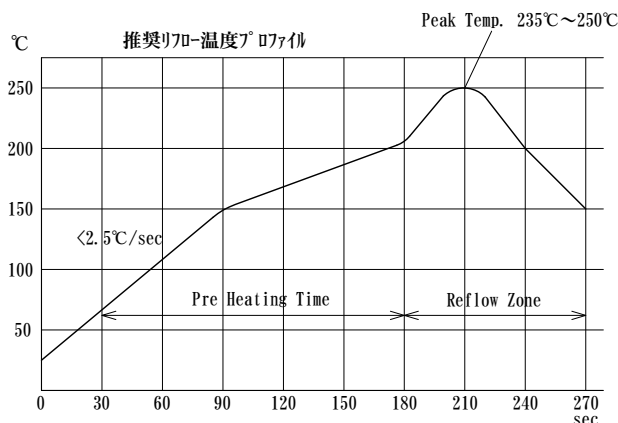
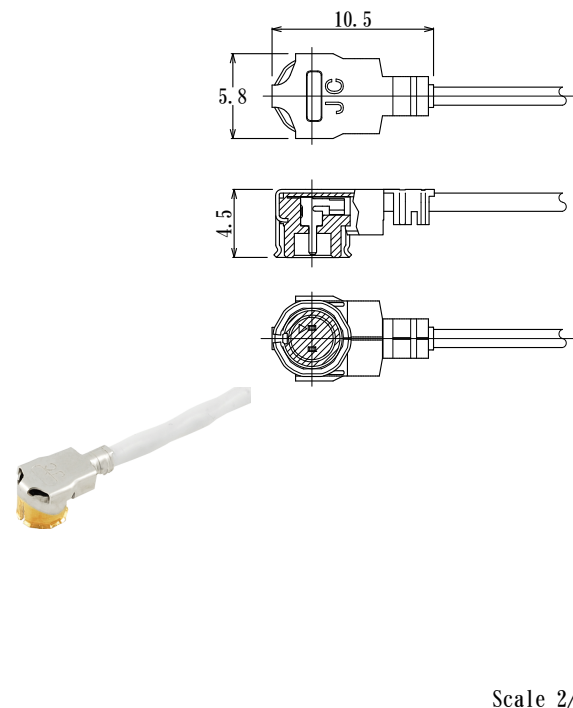

適合ケーブル Cable

CBL-D2RF-2-FEP

Differential Impedance (Ω)	Outer dia.	Insulator dia.	Sheath Outer Colour
100	2.4/0.0945"	0.8/0.0315" x2	White

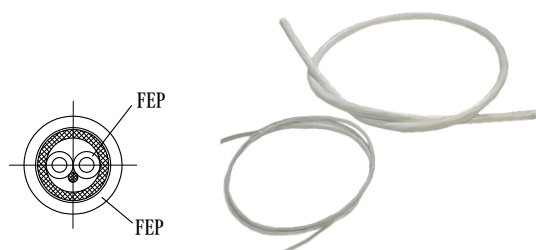

D2RB 差動コネクタ、基板用 100Ω Differential Connectors for PC Board

勘合図

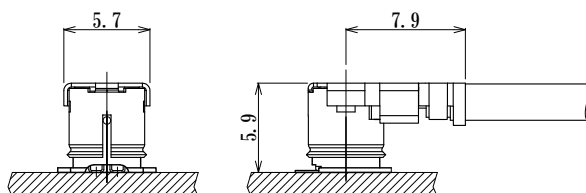

引抜き治具



プラグケーブル組立品 Plug Cable Assy

一定長さを用意しています。細かい組立作業が必要のため
完成品をおすすめします。

D2BF-PXP-50

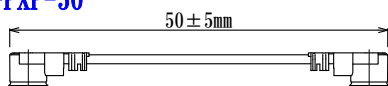

D2BF-PXP-100

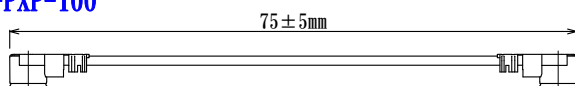

D2BF-PXP-150

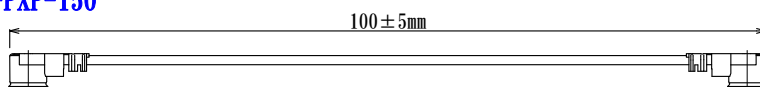

D2BF-P-50

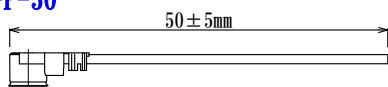

D2BF-P-100

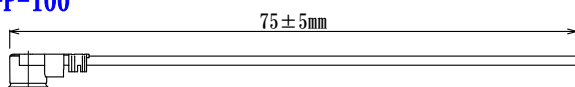

D2BF-P-150

