

## Coaxial Contacts, Solder type

### ■50Ω同軸ストレートプラグ、ケーブルタイプ Coaxial Straight Plug, Cable type

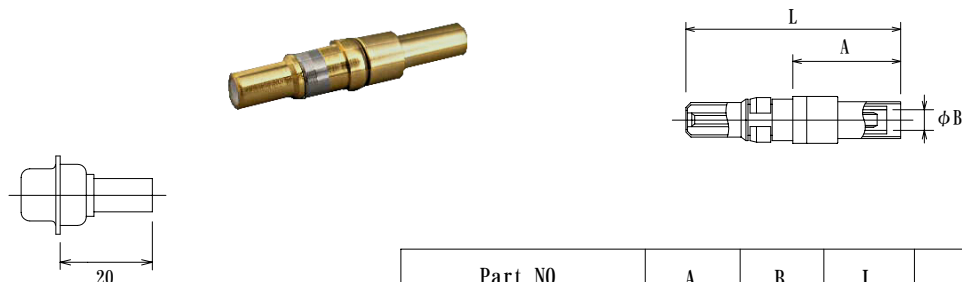

Part NO	A	B	L	適合ケーブル Applicable Cable
<a href="#">DM537P-ST5-174</a>	14.2	1.7	25.6	RG-174/U, RG-179B/U RG-316/U
<a href="#">DM537P-ST5-178</a>	11.7	1.0	23.0	RG-178B/U

### ■50Ω同軸ストレートレセプタクル、ケーブルタイプ Coaxial Straight Receptacle, Cable type

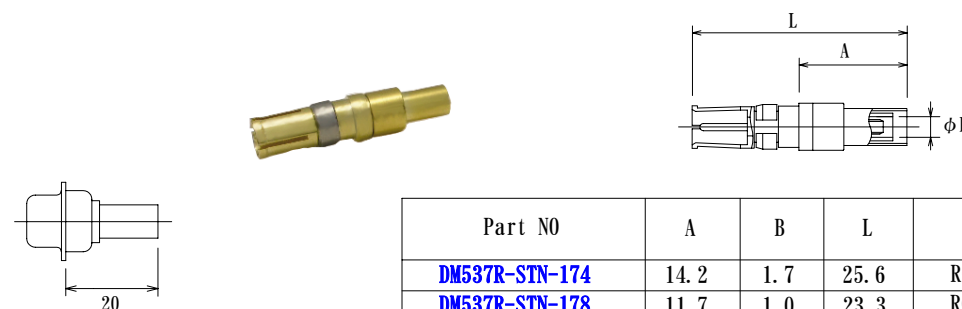

Part NO	A	B	L	適合ケーブル Applicable Cable
<a href="#">DM537R-STN-174</a>	14.2	1.7	25.6	RG-174/U, RG-179B/U RG-316/U
<a href="#">DM537R-STN-178</a>	11.7	1.0	23.3	RG-178B/U

### ■75Ω同軸ストレートプラグ、ケーブルタイプ Coaxial Straight Plug, Cable type

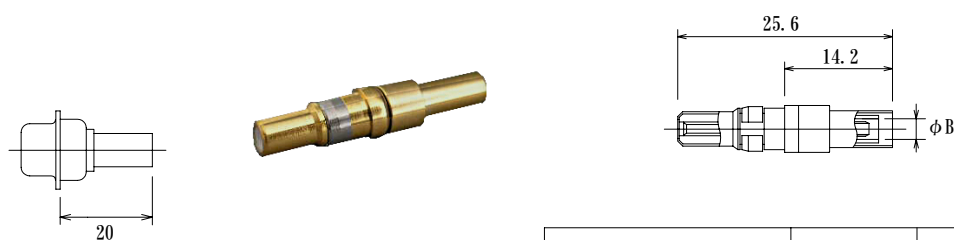

Part NO	B	適合ケーブル Applicable Cable
<a href="#">DM537P75-ST5-179</a>	1.7	RG-179B/U RG-187A/U

### ■75Ω同軸ストレートレセプタクル、ケーブルタイプ Coaxial Straight Receptacle, Cable type



Part NO	B	適合ケーブル Applicable Cable
<a href="#">DM537R75-STN-179</a>	1.7	RG-179B/U RG-187A/U

# Coaxial Contacts, Solder type

■50Ω同軸基板用ライトアングルプラグ、レセプタクル Coaxial Right Angle Plug, Receptacle, Board mount type

3pin type

Plug  
DM537P-PC-L1

Receptacle  
DM537R-PC-L1

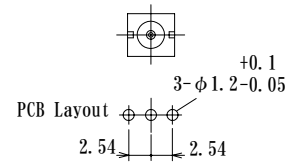
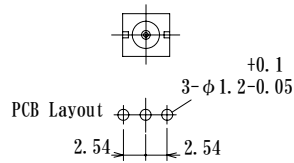
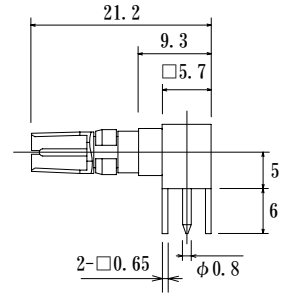
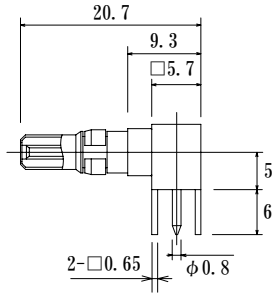

Shell size 15, 25, 37

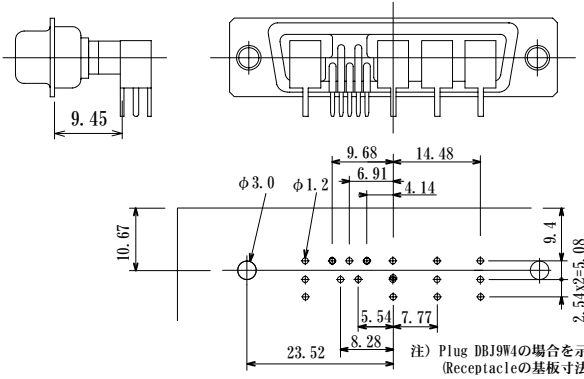

注) Plug DBJ9W4の場合を示します  
 (Receptacleの基板寸法は左右入替になります)

Plug  
DM537P-PC-L2

Receptacle  
DM537R-PC-L2

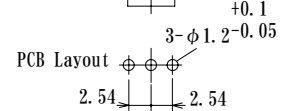
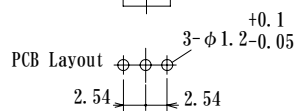
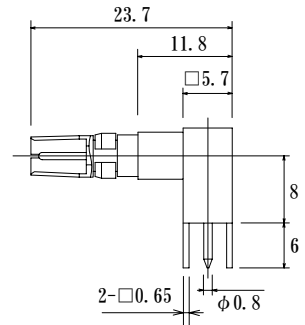
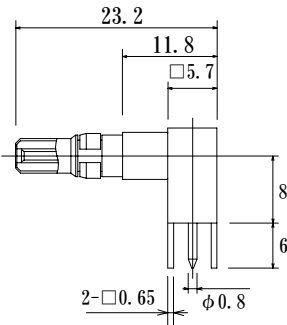

Shell size 50

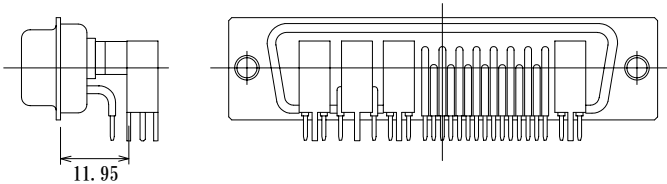

注) Receptacle DDJ36W4の場合を示します  
 (Plugの基板寸法は左右入替になります)

■50Ω同軸ストレートプラグ、レセプタクル 基板取付タイプ Coaxial Straight Plug, Receptacle, Board mount type

3pin type

Plug  
DM537P-PC

Receptacle  
DM537R-PC

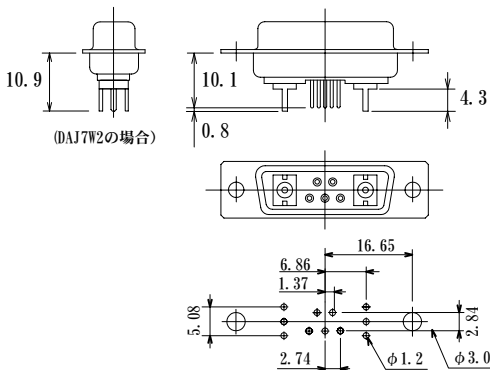
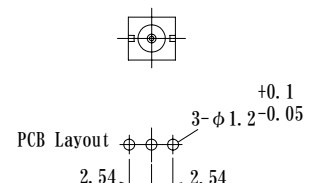
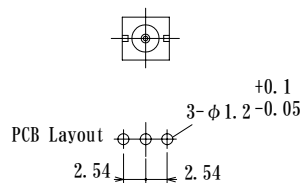
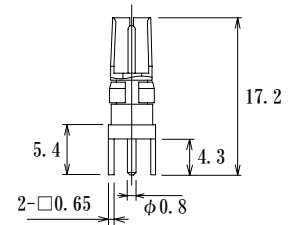
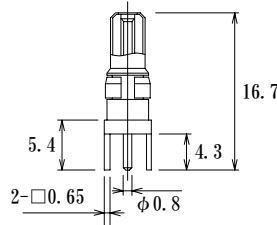

(DAJ7W2の場合)

# Coaxial Contacts, Solder type

■75Ω同軸ライトアングルプラグ、レプタクル 基板取付タイプ Coaxial Right Angle Plug, Receptacle, Board mount type



**Plug**  
DM537P75-PC-L1

**Receptacle** 3pin type  
DM537R75-PC-L1

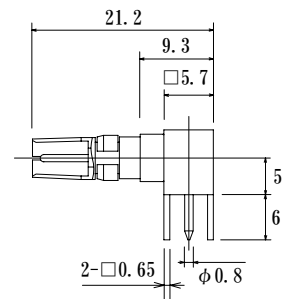
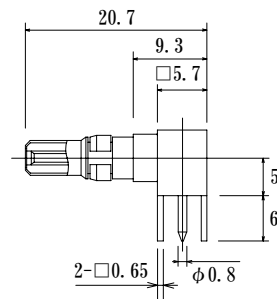

Shell size 15, 25, 37

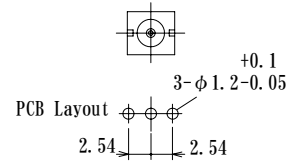
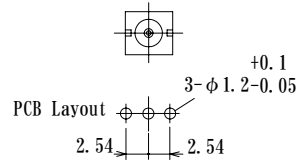
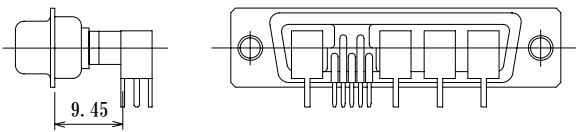

**Plug**  
DM537P75-PC-L2

**Receptacle**  
DM537R75-PC-L2

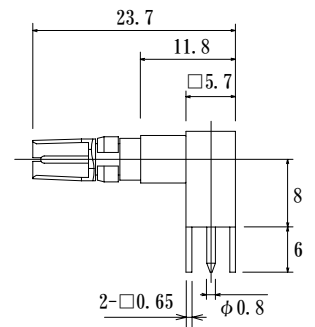
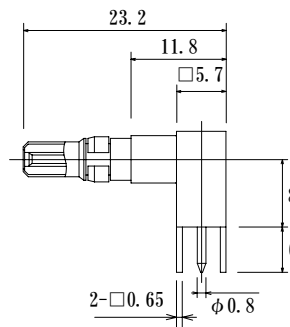

Shell size 50

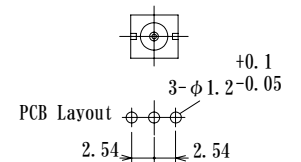
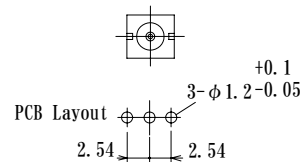
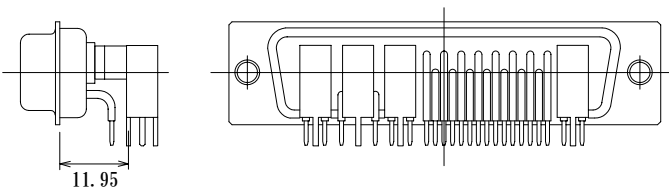

■75Ω同軸ストレートプラグ、レプタクル 基板取付タイプ Coaxial Straight Plug, Receptacle, Board mount type



**Plug**  
DM537P75-PC

**Receptacle** 3pin type  
DM537R75-PC

